

Name: \_\_\_\_\_

1. How many small cubes are in each of the following objects?

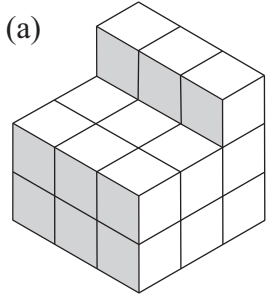

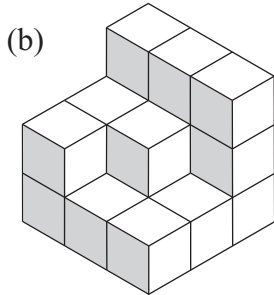

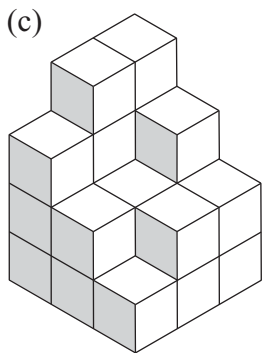

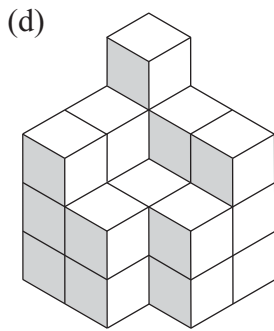

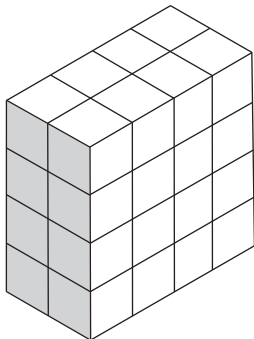

2. (a) How many small cubes are in this object?

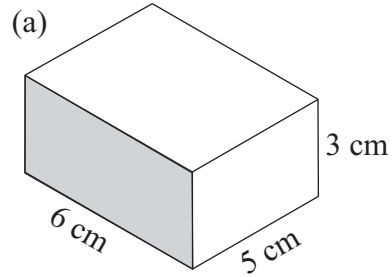

(b) If each of the small cubes in this object is  $1 \text{ cm}^3$ , what is the volume of this object?

3. Find the volume of the following rectangular prisms.

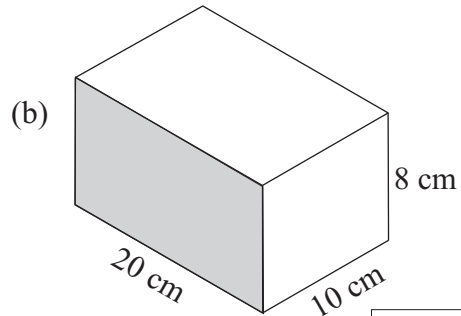



4. Find the volume of the rectangular prisms with the following dimensions.

(a) 7 m long, 4 m wide, 3 m high

(b) 30 m long, 20 m wide, 15 m high

5. Find the volume of the object below.

